

# SUMMERSTEP

## Owner's Manual

Congratulations on your purchase of Summerstep™ snow melting mats, you are about to join thousands of others who kept their stairs and walkways free from ice and snow and made them safe from falls. Please take a moment to read these instructions prior to installing your snow melting mats.

### Warnings and Safety

- Always use a Ground Fault Protection Device (GFCI) when using Summerstep snow melting mats. Each snow melting mat comes with a GFCI preinstalled. The connectable products require a Summerstep power cord to plug in the mat. These power cords come with a GFCI preinstalled.
- Only connect Summerstep products to a properly grounded circuit
- Never connect your Summerstep mats to a voltage higher than what is listed on the cord tag
- Never use ungrounded, worn, or damaged extension cords.
- Never pull, drag, or lift the product by the power cord.
- Never connect to power when the product is rolled up
- Do not use indoors
- Do not use for pets or pet houses
- Do not puncture or cut the product
- Only install on clean surfaces free of gravel, rocks and other debris
- Only use Summerstep power cords and accessories
- Only use for snow melting
- Never exceed the maximum number of amps listed on the cord tag
- As with any electrical device improper installation and usage may result in injury or death
- Never cover the mat when in operation
- Never install a mat on an icy surface

### Installation Guide

#### Step 1 – Prepare the area and place the mat in the desired area (All Summerstep Mats)

Summerstep snow melting mats are intended to be installed on ice free surfaces that are free of any debris. Small rocks, gravel, or other objects can damage the Summerstep mat. Always clean the area prior to installation.

Each Summerstep snow melting mat comes with a non-slip textured surface. For proper function of the mat the textured surface must be face up. Failure to do so will result in poor performance.

Place the mat in the desired location; always place the cord off to the side of the walking path. Never place the cord in a location where it could become a tripping hazard.

#### Step 2 – Connect mats together (All connectable Summerstep Models)

There are three types of connectable models: Door mats, Stair Mats and Walkway Mats.

Connectable door mats (see Figure 3) come with a standard power cord preinstalled and have a female connector that allows you to connect to either a stair mat or a walkway mat.

Connectable Stair Mats (See Figure 2) and Walkway Mats (see Figure 4) come with male and female water proof connectors that connect to the Connectable Power Cord.

Stair mats and walkway mats will require a Connectable Power Cord (See Figure 5); if you choose to use the door mat then a Connectable Power Cord is not required as it is part of the Summerstep Door Mat.

**⚠ WARNING: ONLY connect Summerstep mats together, do not connect other products to Summerstep mats.**

If the power cord cannot reach the mat or the Male and Female cords are too far apart to connect you will need to install an extension cord (see Figure 6). Summerstep extension cords are available in 2' or 25' lengths.

When connecting mats together you cannot exceed the current rating on the cord tag (See Figure 1). The cord tag can be found attached to every Summerstep mat. This value is typically 12 amps for both 120V and 240V. However for some custom products this amperage may be higher. Never exceed 80% current on a circuit breaker. Most homes are equipped with a 15 amp circuit breaker on each circuit.

SUMMERSTEP			
MODEL	REVISION		
VOLTS	XXX VAC	WATTS	XXX
HERTZ	XX/XX	AMPS	X.XX
PHASE	XXXXXX	OHMS	XX.XX
DATE	XX/XX		

CAUTION: A GROUND FAULT PROTECTION DEVICE MUST BE USED WITH THIS HEATING DEVICE

NEVER CONNECT MATS TOGETHER TO EXCEED 80% CBA OR XX AMPS

NEVER CONNECT ANYTHING OT RECEPTACLE EXCEPT SUMMERSTEP HEATED MATS.

DO NOT REMOVE THIS TAG

Figure 1 – Summerstep Cord Tag

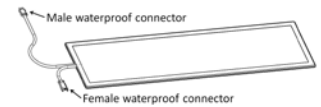

Figure 2 – Summerstep Stair Mat

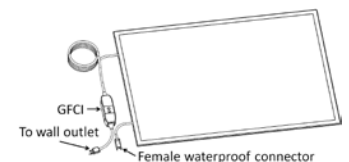

Figure 3 – Summerstep Connectable Door Mat

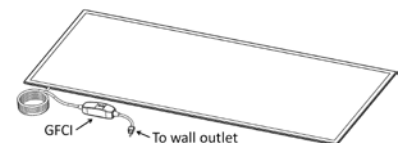

Figure 4 – Summerstep Connectable Walkway Mat

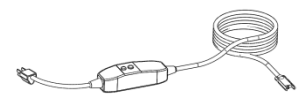

Figure 5 – Summerstep 120V Connectable Power Cord



Figure 6 – Summerstep Connectable 25 Foot Extension Cord

# SUMMERSTEP

## Owner's Manual

### Step 2 (continued)

#### Amp calculation example:

If you are installing a snow melting mat system on a 120VAC circuit that has a 15 amp breaker the maximum allowable current would be 80% of 15 amps or 12 amps (the cord tag states the maximum amperage 12 amps). You MUST stay below the maximum amperage written on the cord tag.

If you have a small landing in front of your door, seven stairs and then a walk way that is 10 feet long you would need: One door mat (1.5A), seven stair mats (0.6A) and two walkway mats (2.6A) and your total amperage would be  $1 \times 1.5 + 7 \times 0.6 + 2 \times 2.6 = 10.9$  amps, less than 12 amps, which is acceptable.

**WARNING:** Do not plug mats into outlet until all mats are connected and the end cap is securely placed on the last female connectors of the mats.

If not using the connectable door mat connect the power cord (see Figure 5) to the first mat of the series (see Figure 8)

Connect remaining mats in series together (See Figure 7)

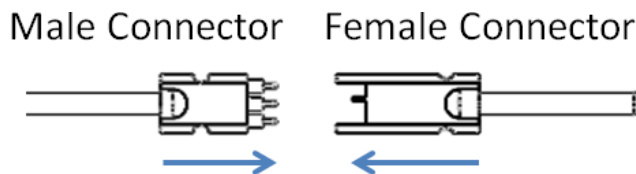

Figure 7 - Connect mats

At the end of the series of mats you must install an end cap. Failure to do so will result in the mats not functioning properly and possibly electrocution (See Figure 9)

**REMEMBER:** When connecting mats together do not exceed the amp rating of the mats or 80% of the breaker rating.

Table 1 - Example amp calculation

P/N	Description	Amps	QTY	Total Amps
DM24x36C	Door Mat, 2'x3', Connectable	1.5	1	1.5
SM11x36	Stair Mat, 11"x3'	0.6	7	4.2
WM24x60C	Walkway Mat, 2'x5' Connectable	2.6	2	5.2

10.9

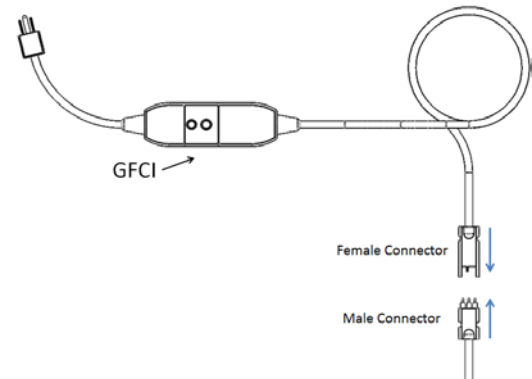

Figure 8 - Connect first mat to power cord

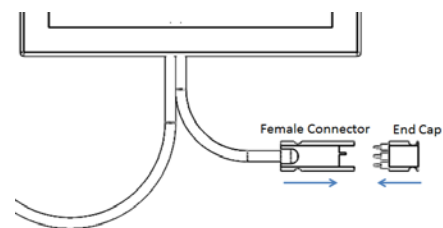

Figure 9 - End Cap Installation

### Step 3 - Connect mat(s) to power source (All Summerstep Mats)

Non-Connectable models have a power cord with a GFCI and plug preinstalled on the mat (See Figure 10). Connectable door mats also have a power cord preinstalled, but are connectable because stair mats and connectable walkway mats can plug directly into the connectable door mat.

Plug the cord into the appropriate wall outlet

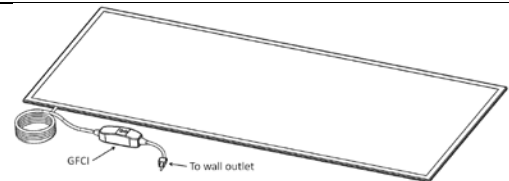

Figure 10 - Non Connectable Summerstep Walkway Mat

### Step 4 - Check GFCI

After connecting the mats to the wall outlet press the "TEST" button on the GFCI. This should kill power to the mats. Press the "RESET" button to reset the GFCI.

**WARNING:** The GFCI is designed to trip if the system detects current leakage. This is to protect people from electrocution. It is necessary to have the outlet properly grounded by a licensed electrician otherwise this protective device will not protect against electrocution.

### Step 5 - Securing the mats (Optional)

You may choose to secure your mats to the surface they are on. This will prevent the mats from being blown around or shifting over time. Grommets are installed on each corner to make securing the mats simple and easy.

Use a stainless steel or galvanized screws to adhere the mats to the surface.

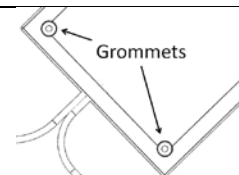

Figure 11 - Grommets

### Storage and Maintenance

For best results and power savings only turn on Summerstep snow melting mats when temperatures are below 35F.

After the winter season store the mats indoors.

Always inspect the mat and cord for damage prior to installation.